

COLD FORGING DIES

➤ *Grade, Properties and Application*

Grades	Density g/cm ³	T.R.S MPa	Hardness HRA	Performance & application recommended
YG11	14.4	2600	88.5	Forming or stamping dies for metal powders and nonmetal powders.
YG15	14.0	2800	87.5	For fabricating drawing dies of steel tubes and rods under High compressibility ratio; punching, stamping, forging tools under large stress.
YG20	13.5	3200	85.5	For fabricating of stamping dies for watch parts, spring plates of musical instruments, battery jars, small sized steel balls, screws, screw caps.
YG16C	13.9	2900	85.5	Impact resistance forging dies.
YG18C	13.7	3100	84.5	Impact resistance forging dies, hot-press forging dies and rollers.
YG20C	13.5	3300	83.5	Dies for wear resistant or impact resistant application.
YG22C	13.3	3500	83.0	Nut forming dies and high impact resistance forging dies.
YG25C	13.1	3600	82.5	Stainless bolt header dies and rollers.

➤ *Product Information*

BDP SERIES

Heading die blanks to make standard bolts

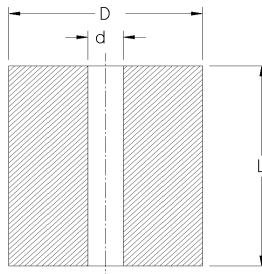
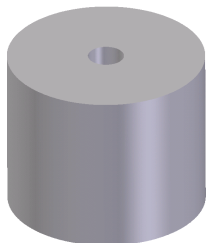

TYPE	DIMENSION (MM)			APPLICATION AREA
	d	D	L	
BDP151020	1.5	10	20.0	M2
BDP151220	1.5	12	20.0	M2
BDP151426	1.5	14.4	26.0	M2
BDP151631	1.5	16.4	31.0	M2
BDP201841	2.0	18.4	41.0	M2.5
BDP202050	2.0	20	50.0	M2.5
BDP202638	2.0	26	38.0	M2.5
BDP211630	2.1	16	30.0	M3
BDP212550	2.1	25	50.0	M3
BDP251630	2.5	16	30.0	M3
BDP282250	2.8	22	50.0	M4
BDP302530	3.0	25	30.0	M4
BDP303030	3.0	30	30.0	M4
BDP303560	3.0	35	60.0	M4
BDP304570	3.0	45	70.0	M4
BDP381420	3.8	14	20.0	M5
BDP383050	3.8	30	50.0	M5
BDP403060	4.0	30	60.0	M5
BDP404560	4.0	45	60.0	M5
BDP462260	4.6	22	60.0	M6
BDP521840	5.2	18	40.0	M6
BDP521860	5.2	18	60.0	M6
BDP542250	5.4	22	50.0	M6
BDP561620	5.6	16	20.0	M6
BDP603060	6.0	30	60.0	M8
BDP6044110	6.0	44	110.0	M8
BDP623232	6.2	32	32.0	M8
BDP642230	6.4	22	30.0	M8
BDP642540	6.4	25	40.0	M8
BDP643025	6.4	30	25.0	M8
BDP643040	6.4	30	40.0	M8
BDP652030	6.5	20	30.0	M8
BDP692240	6.9	22	40.0	M8
BDP692260	6.9	22	60.0	M8

TYPE	DIMENSION (MM)			APPLICATION AREA
	d	D	L	
BDP703050	7.0	30	50.0	M10
BDP704020	7.0	40	20.0	M10
BDP704865	7.0	48	65.0	M10
BDP7050100	7.0	50	100.0	M10
BDP723030	7.2	30	30.0	M10
BDP723050	7.2	30	50.0	M10
BDP753136	7.5	31	36.0	M10
BDP803060	8.0	30	60.0	M10
BDP804020	8.0	40	20.0	M10
BDP823040	8.2	30	40.0	M10
BDP823060	8.2	30	60.0	M10
BDP843560	8.4	35	60.0	M10
BDP903060	9.0	30	60.0	M12
BDP903560	9.0	35	60.0	M12
BDP923050	9.2	30	50.0	M12
BDP1003060	10.0	30	60.0	M12
BDP1003540	10.0	35	40.0	M12
BDP1003560	10.0	35	60.0	M12
BDP1004040	10.0	40	40.0	M12
BDP1005025	10.0	50	25.0	M12
BDP1005050	10.0	50	50.0	M12
BDP1144040	11.4	40	40.0	M12
BDP1183530	11.8	35	30.0	M12
BDP1184040	11.8	40	40.0	M12
BDP1202225	12.0	22	25.0	M12
BDP1203060	12.0	30	60.0	M12
BDP1204040	12.0	40	40.0	M12
BDP1204520	12.0	45	20.0	M12
BDP1253560	12.5	35	60.0	M12
BDP1304040	13.0	40	40.0	M14
BDP1383520	13.8	35	20.0	M16
BDP1383545	13.8	35	45.0	M16
BDP1384020	13.8	40	20.0	M16
BDP1384030	13.8	40	30.0	M16
BDP1384045	13.8	40	45.0	M16
BDP1384525	13.8	45	25.0	M16
BDP1404563	14.0	45	63.0	M18
BDP1453548	14.5	35	48.0	M18
BDP1504040	15.0	40	40.0	M18
BDP1504560	15.0	45	60.0	M18
BDP1544520	15.4	45	20.0	M18
BDP1544540	15.4	45	40.0	M18
BDP1604040	16.0	40	40.0	M18
BDP1644040	16.4	40	40.0	M20
BDP1644560	16.4	45	60.0	M20
BDP1704040	17.0	40	40.0	M20
BDP1704520	17.0	45	20.0	M20
BDP1704555	17.0	45	55.0	M20

TYPE	DIMENSION (MM)			APPLICATION AREA
	d	D	L	
BDP1704575	17.0	45	75.0	M20
BDP1705030	17.0	50	30.0	M20
BDP1724048	17.2	40	48.0	M20
BDP1754040	17.5	40	40.0	M20
BDP1764560	17.6	45	60.0	M20
BDP1805540	18.0	55	40.0	M20
BDP1824048	18.2	40	48.0	M20
BDP1904560	19.0	45	60.0	M22
BDP2005060	20.0	50	60.0	M22
BDP2104550	21.0	45	50.0	M22
BDP2105020	21.0	50	20.0	M22
BDP2105045	21.0	50	45.0	M22
BDP2185020	21.8	50	20.0	M22
BDP2205020	22.0	50.2	20.0	M24
BDP2205530	22.0	55	30.0	M24
BDP2006040	20.0	60	40.0	M24
BDP2257040	22.5	70	40.0	M24
BDP2305085	23.0	50	85.0	M25
BDP2387030	23.8	70	30.0	M25
BDP2404530	24.0	35	30.0	M25
BDP2405050	24.0	50	50.0	M27
BDP2505030	25.0	50	30.0	M27
BDP2505020	25.0	50.2	20.0	M27
BDP2505530	25.0	55	30.0	M28
BDP2606025	26.0	60.2	25.0	M30
BDP2706527	27.0	65	27.0	M30
BDP2806527	28.0	65	27.0	M32
BDP2857030	28.5	70	30.0	M34
BDP2957540	29.5	75	40.0	M34
BDP3005530	30.0	55	30.0	M34
BDP3006030	30.0	60	30.0	M34
BDP3057550	30.5	75	50.0	M34
BDP3157040	31.5	70	40.0	M36
BDP3306530	33.0	65	30.0	M38
BDP3307035	33.0	70	35.0	M38
BDP3307535	33.0	75	35.0	M38
BDP3758530	37.5	85	30.0	M42
BDP3808040	38.0	80	40.0	M42
BDP3809033	38.0	90	33.0	M42
BDP3808540	38.0	85	40.0	M42
BDP4208040	42.0	80	40.0	M46
BDP4208540	42.0	85	40.0	M50
BDP45010060	45.0	100	60.0	M50
BDP45010080	45.0	100	80.0	M50
BDP4758530	47.5	85	30.0	M52
BDP5009550	50.0	95	50.0	M54
BDP5209040	52.0	90	40.0	M56
BDP60010040	60.0	100	40.0	M64

TYPE	DIMENSION (MM)			APPLICATION AREA
	d	D	L	
BDP61510020	61.5	100	20.0	M66
BDP70012040	70.0	120	40.0	M76
BDP80013040	80.0	130	40.0	M84
BDP85014040	85.0	140	40.0	M90

BC SERIES

Die blanks with sink

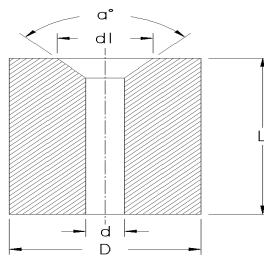
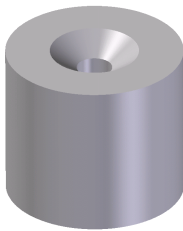

TYPE	DIMENSION (MM)					TYPE	DIMENSION (MM)				
	d	D	L	d1	α°		d	D	L	d1	α°
BC281330	2.8	13	30	7	90	BC643030	6.4	30	30	15	90
BC381630	3.8	16	30	8.5		BC643055	6.4	30	55	15	
BC381640	3.8	16	40	8.5		BC823655	8.2	36	55	18	
BC382250	3.8	22	50	8.5		BC1004055	10.0	40	55	22	
BC461630	4.6	16	30	10.5		BC1004555	10.0	45	55	22	
BC462250	4.6	22	50	10.5		BC1386060	13.8	60	60	29	

BS SERIES

Die blanks for reducing diameter of nuts

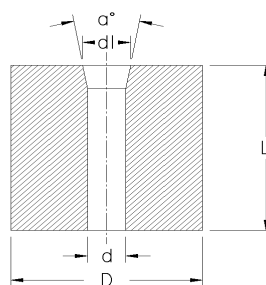
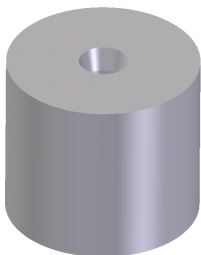

TYPE	DIMENSION (MM)					TYPE	DIMENSION (MM)				
	d	D	L	d1	α°		d	D	L	d1	α°
BS2114-	2.1	14	15~30	2.5	20	BS8430-	8.4	30	25~54	9.3	20
BS2116-	2.1	16	15~30	2.5		BS10030-	10.0	30	14~20	11.4	
BS3114-	3.1	14	15~30	3.5		BS10228-	10.2	28	25~54	11.4	
BS3116-	3.1	16	15~30	3.5		BS10230-	10.2	30	25~54	11.4	
BS3914-	3.9	14	15~35	4.5		BS11940-	11.9	40	30~40	13.2	
BS3916-	3.9	16	15~35	4.5		BS12040-	12.0	40	10~14	13.4	

TYPE	DIMENSION (MM)					TYPE	DIMENSION (MM)				
	d	D	L	d1	α°		d	D	L	d1	α°
BS4516-	4.5	16	10~20	5.9		BS14040-	14.0	40	14~20	15.4	12
BS4716-	4.7	16	15~35	5.4		BS17545-	17.5	45	14~20	19.3	
BS4718-	4.7	18	20~35	5.4		BS19545-	19.5	45	20~30	21.25	
BS6520-	6.5	20	20~42	7.2		BS21050-	21.0	50	20~30	22.75	
BS6522-	6.5	22	10~42	7.9		BS24060-	24.0	60	25~30	25.75	
BS8030-	8.0	30	10~20	9.4		BS26560-	26.5	60	25~30	28.63	
BS8426-	8.4	26	25~54	9.3		BS32070-	32.0	70	25~30	34.13	

BR SERIES

Punching die blanks for batteries

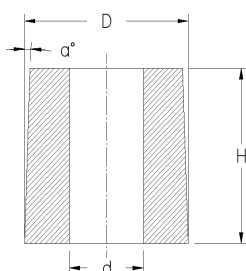
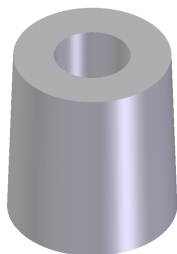

TYPE	DIMENSION (MM)			
	d	D	H	α°
BR902022	9.0	20	22	1°30'
BR942022	9.4	20	22	
BR1042120	10.4	21	20	
BR1222520	12.2	25	20	
BR1253022	12.5	30	22	
BR1302520	13.0	25	20	
BR1303022	13.0	30	22	
BR1883622	18.8	36	22	
BR1923622	19.2	36	22	
BR1943220	19.4	32	20	
BR2204022	22.0	40	22	
BR2253820	22.5	38	20	
BR2254022	22.5	40	22	
BR2354022	23.5	40	22	
BR2393820	23.9	38	20	
BR2424022	24.2	40	22	
BR2884720	28.8	47	20	
BR3084720	30.8	47	20	
BR3124622	31.2	46	22	
BR3184720	31.8	47	20	

BF SERIES

Heading die blanks to make hexagonal nuts

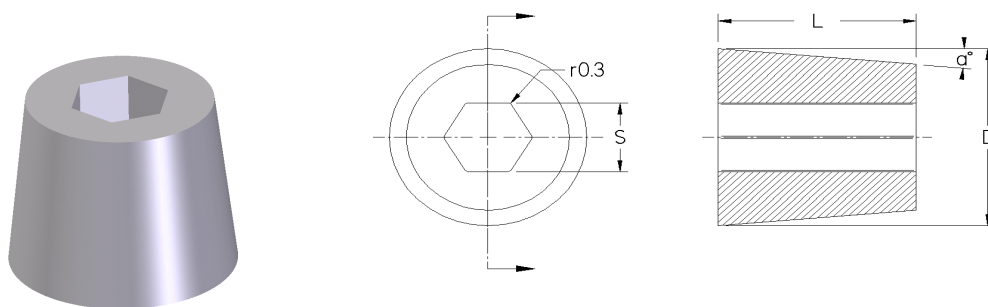

TYPE	DIMENSION (MM)				TYPE	DIMENSION (MM)			
	S	D	L	α°		S	D	L	α°
BF2612-	2.6	12	8~12	—	BF12028-	12.0	28	18	5-7
BF3316-	3.3	16	8~12	—	BF12132-	12.1	32	8~22	—
BF3412-	3.4	12	8~12	—	BF13236-	13.2	36	20~34	—
BF4316-	4.3	16	8~12	—	BF13728-	13.7	28	12	5-7
BF4416-	4.4	16	10~14	—	BF14036-	14.0	36	25	5-7
BF4816-	4.8	16	12~16	—	BF15040-	15.0	40	22~34	—
BF4820-	4.8	20	12~16	—	BF16734-	16.7	34	12	5-7
BF6120-	6.1	20	5	5-7	BF17039-	17.0	39	30	5-7
BF6320-	6.3	20	14~18	—	BF17044-	17.0	44	26~34	—
BF7220-	7.2	20	6	5-7	BF17936-	17.9	36	13.5	5-7
BF7224-	7.2	24	14~18	—	BF19044-	19.0	44	18.5	5-7
BF7328-	7.3	28	14~22	—	BF19952-	19.9	52	34~38	—
BF8920-	8.9	20	7	5-7	BF20543-	20.5	43	16.5	5-7
BF9022-	9.0	22	8	5-7	BF22458-	22.4	58	20.5	5-7
BF9126-	9.1	26	16	5-7	BF22858-	22.8	58	36~44	—
BF9230-	9.2	30	14~18	—	BF22863-	22.8	63	44.5	5-7
BF9328-	9.3	28	14~22	—	BF22944-	22.9	44	17.0	5-7
BF11236-	11.2	36	20~34	—	BF28172-	28.1	72	45~55	—
BF11732-	11.7	32	19	5-7	BF28759-	28.7	59	24.0	5-7

BG SERIES

Punching die blanks to make steel balls

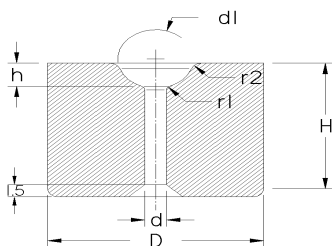
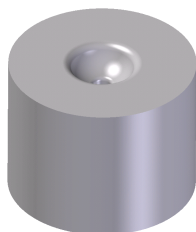

Type	Dimension mm								
	d1	D	H	d	h	r1	r2		
BG1812102	1.8	12.2	10.2	0.8	0.5	0.4	1.0		
BG2212102	2.2				0.7				
BG2612102	2.6			0.9	0.9				
BG3012102	3.0				1.2				
BG3412102	3.4				1.3				
BG3812102	3.8				1.5				
BG4212102	4.2				1.7				
BG4812102	4.8				2.0				
BG5215122	5.2	15.2	12.2	1.3	2.2	0.6	1.5		
BG5615122	5.6				2.3				
BG6015122	6.0				2.5				
BG6515122	6.5				2.8				
BG6820152	6.8	20.2	15.2	1.8	2.8				
BG7320152	7.3				3.1				
BG8120152	8.1				3.5				
BG8620152	8.6			3.8					
BG9625202	9.6			25.3	20.2	2.3	4.2	0.8	2.0
BG10225202	10.2						4.6		
BG10525202	10.5	5.0							
BG11225202	11.2	5.0							
BG11630202	11.6	30.3	25.2			2.8	5.0		
BG12030202	12.0						5.4		
BG12430202	12.4						5.6		
BG12830202	12.8					5.8			
BG13730202	13.7			6.2					
BG14030202	14.0			6.2					
BG14530202	14.5	35.4	25.2	3.3	6.6				
BG15335252	15.3				7.0				
BG16035252	16.0				7.3				
BG16835252	16.8			7.7					
BG17235252	17.2			7.7					
BG17640252	17.6			40.4	30.2	3.8	8.0		
BG18440252	18.4	8.3							
BG19240252	19.2	8.7							
BG20045302	20.0	9.1							
BG20845302	20.8	9.5							
BG21645302	21.6	9.8							
BG22445302	22.4	45.4	30.2	3.8	10.2	1.0	2.5		
BG22445302	22.4				10.2				

Type	Dimension mm						
	d1	D	H	d	h	r1	r2
BG23250302	23.2	50.4		4.3	10.6		
BG24050302	24.0				11.0		
BG24850302	24.8				11.4		
BG25550302	25.5				11.8		

BP SERIES

Combination die blanks to make hexagonal nuts

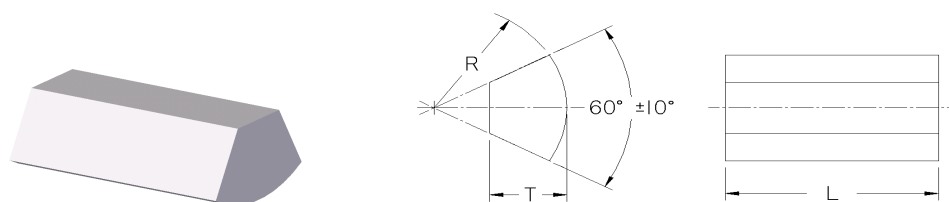

Type	Dimension (mm)			Type	Dimension (mm)		
	R	T	L		R	T	L
BP1100621	11.0	6	21	BP2501432	25.0	14.0	32
BP1100721	11.0	7	21	BP2601223	26.0	12.5	23
BP1300621	13.0	6.5	21	BP2601237	26.0	12.0	37
BP1500820	15.0	8	20	BP2751436	27.5	14.0	36
BP1601220	16.0	12	20	BP2801132	28.0	11.0	23
BP1800921	18.0	9	21	BP2801323	28.0	13.0	23
BP1801021	18.0	10	21	BP2801143	28.0	11.0	43
BP1800929	18.0	9	29	BP2801343	28.0	13.0	43
BP1801029	18.0	10	29	BP2901835	29.0	18.0	35
BP2001028	20.0	10.5	28	BP3001442	30.0	14.0	42
BP2001128	20.0	11.5	28	BP3001542	30.0	15.0	42
BP2251328	22.5	13.0	28	BP3101347	31.0	13.0	47
BP2251428	22.5	14.0	28	BP3251446	32.5	14.5	46
BP2301121	23.0	11.0	21	BP3301226	33.0	12.5	26
BP2301221	23.0	12.5	21	BP3301251	33.0	12.5	51
BP2301133	23.0	11.0	33	BP3601326	36.0	13.0	26
BP2301233	23.0	12.5	33	BP3601358	36.0	13.0	56
BP2501332	25.0	13.0	32				

HQ SERIES

Cutters for cutting materials

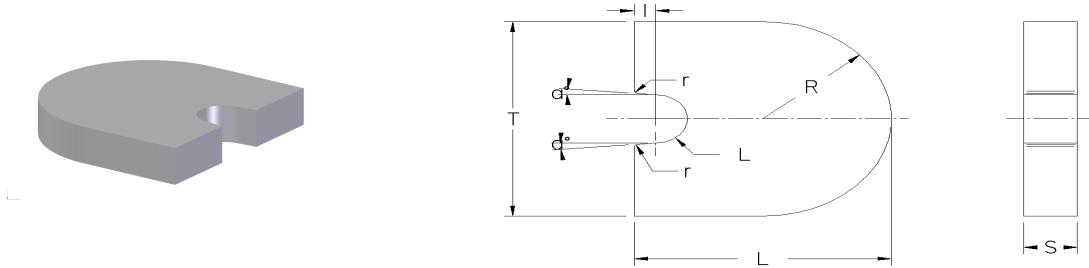

Type	Dimension (mm)							
	d	T	L	S	I	R	α°	r
HQ201012	2	10	12	1	—	5	—	—
HQ341616	3.4	16	16	2.5	—	8	—	—
HQ461616	4.6	16	16	4	—	8	—	—
HQ541616	5.4	16	16	5	—	8	—	—
HQ641012	6.4	10	12	2	—	5	—	—
HQ641616	6.4	16	16	5	—	8	—	—
HQ402525	4	25	25	3	5	12.5	5	—
HQ842222	8.4	22	22	5.5	—	11	—	—
HQ942222	9.4	22	22	8	—	11	—	—
HQ802525	8	25	25	4.5	5	12.5	5	—
HQ803030	8	30	30	6	5	15	5	0.5
HQ1003030	10	30	30	10	3	15	6	—
HQ1403635	14	36	35	13	3	18	6	—

Notes: other sizes of cold forging dies can be provided upon your requests.